

United States
Department of
Agriculture

Forest Service

Technology &
Development
Program

5100—Fire Management
December 2002
0251 1205—SDTDC



Water Ejectors for Use in Wildland Firefighting



Water Ejectors for Use in Wildland Firefighting



Lois Sicking
Mechanical Engineer

USDA Forest Service

San Dimas Technology and Development
Center
San Dimas, CA

December 2002

Information contained in this document has been developed for the guidance of employees of the U.S. Department of Agriculture (USDA) Forest Service, its contractors, and cooperating Federal and State agencies. The USDA Forest Service assumes no responsibility for the interpretation or use of this information by other than its own employees. The use of trade, firm, or corporation names is for the information and convenience of the reader. Such use does not constitute an official evaluation, conclusion, recommendation, endorsement, or approval of any product or service to the exclusion of others that may be suitable.

The U.S. Department of Agriculture (USDA) prohibits discrimination in all its programs and activities on the basis of race, color, national origin, sex, religion, age, disability, political beliefs, sexual orientation, or marital or family status. (Not all prohibited bases apply to all programs.) Persons with disabilities who require alternative means for communication of program information (Braille, large print, audiotape, etc.) should contact USDA's TARGET Center at (202) 720-2600 (voice and TDD).

To file a complaint of discrimination, write USDA, Director, Office of Civil Rights, Room 326-W, Whitten Building, 1400 Independence Avenue, SW, Washington, D.C. 20250-9410 or call (202) 720-5964 (voice and TDD). USDA is an equal opportunity provider and employer.

Table of Contents

INTRODUCTION	1
EJECTOR TECHNOLOGY	1
EJECTOR HYDRAULICS	1
BENEFITS OF USING AN EJECTOR OVER SUCTION DRAFTING	1
EJECTOR FIELD TEST PROCEDURE	2
EJECTOR PERFORMANCE MAPPING	3
EJECTOR SELECTION	3
EJECTOR SETUP	4
EXAMPLES OF EJECTOR USE	4
FRICITION LOSS	6
DUAL RETURN LINES TO OPTIMIZE LIFT CAPACITY	7
EJECTOR TROUBLESHOOTING	8
EJECTOR SPECIFICATIONS AND DESCRIPTIONS	9
EJECTOR MANUFACTURER INFORMATION	9
RELATED PUBLICATIONS	9
APPENDIX A Ejector Performance Charts	11
APPENDIX B Mapping Ejector Performance Comparisons	25
APPENDIX C Comparisons of Ejectors From Greatest to Least Water Pickup	31
APPENDIX D Friction Loss of Forestry Hoses	35
APPENDIX E Product Descriptions of Ejectors and Required Connections and Fittings	39
ENGLISH TO METRIC CONVERSION FACTORS USED IN THIS DOCUMENT	44

INTRODUCTION

Wildland firefighters have two methods of drafting water from a natural water source: suction drafting and ejector drafting. Ejectors can draft water over longer distances and at lifts greater than 22 ft, well beyond the capability of suction drafting. This extends the range of standard engines in wildland firefighting to obtain water sources normally classed as inaccessible. Ejectors are especially useful when water tenders are not readily available. They significantly reduce tank refill time and can provide water directly to a nozzle in wildland firefighting operations. They have proven to be an inexpensive effective tool for drafting water for many years.

San Dimas Technology and Development Center has assessed drafting capabilities and water pickup effectiveness of nine commercially available water ejectors applicable to wildland firefighting. Ejectors were evaluated for their ability to draft water across both level and sloped surfaces, with distances up to 300 ft from natural water sources and lifts up to 80 ft.

Ejectors are available in various sizes and capacities. Ejectors with a 1½-in outlet have input capacities up to 44 gpm, a maximum water pickup effectiveness of up to approximately 167 percent, a weight of 1.2 to 3.7 lb, and a cost that varies from \$122 to \$215. Ejectors with a 2½-in outlet have input capacities up to 330 gpm, maximum water pickup effectiveness of up to approximately 93 percent, a weight of 4.8 to 11.0 lb, and a cost that varies from \$290 to \$412.

EJECTOR TECHNOLOGY

An ejector integrates a nozzle and a venturi to create suction that picks up additional water from a natural or portable water source. A venturi is a narrowing of a piped waterway. As water passes through the narrowed waterway, the water velocity increases and the pressure of the water is reduced. Downstream, the passage widens, causing the velocity of the water to decrease and the pressure to increase. This change in pressure creates suction (figure 1).

Ejectors have no moving parts. When an ejector is placed in hydrostatic water, no suction is created: pressurized water must be supplied to the inlet of the ejector. Water at the ejector inlet flows through a nozzle that directs a high velocity stream of water through the venturi. This high velocity stream provides the flow necessary to cause the negative pressure, or suction, in the area between the nozzle and venturi. Water is picked up at the suction opening into the venturi, and the combined flow is discharged.

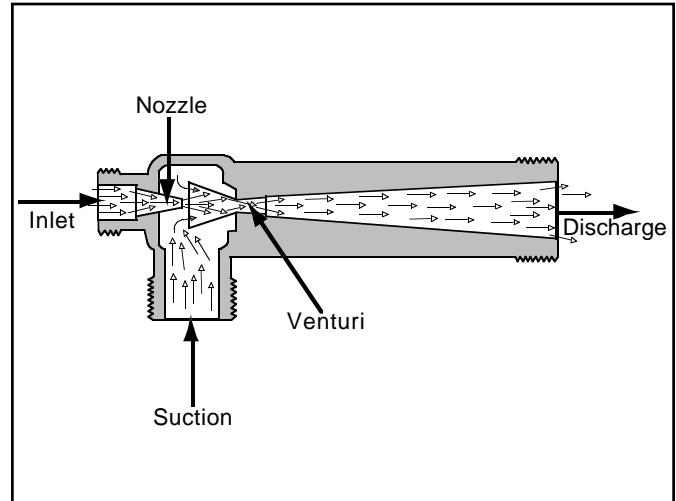

Figure 1—Typical ejector configuration for use in water ejector drafting operations.

EJECTOR HYDRAULICS

When a pump drafts water vertically, air is removed under atmospheric pressure from the inside of the suction hose, creating a vacuum. Atmospheric pressure at sea level exerts a pressure of 14.7 psi onto everything, including water. A pressure of 14.7 psi is capable of lifting a column of water 33.9 ft in height, or 2.3 ft for every pound of pressure.

Theoretically, if a pump could produce a perfect vacuum, the greatest height that water could be lifted from a supply reservoir at sea level would be 33.9 ft. However, no pump can produce a perfect vacuum. A good, serviceable fire pump at sea level can lift water approximately 22 ft and maintain suction.

BENEFITS OF USING AN EJECTOR OVER SUCTION DRAFTING

The primary benefit of using an ejector is being able to draft water vertically to heights greater than 22 ft over long, sloping terrain. See table 1. Ejectors can draw water from sources that are normally inaccessible to standard engines due to terrain, fences, soil too soft to support an engine, deep wells, or other obstructions. Water can be lifted from rivers and creeks even if the water level is 100 ft below a roadbed or bridge crossing. Rivers and lakes up to 300 ft from the road are readily available for tank refill. By using an ejector, an engine can refill the tank in half the time, or at a flow rate of up to two times the output. Ejectors also can be used to fill a primary and mother tank simultaneously.

Water Ejectors for Use in Wildland Firefighting

A pump's ability to lift water by suction is seriously affected by a loose suction hose coupling, leaky gaskets, poor packing, or small leaks. Connections and fittings used with an ejector need to be only hand tight, as small leaks will not significantly affect ejector operation.

Consider using ejectors for all drafting operations—even dirty, sand-laden water can be utilized for firefighting. They can also be used to draft water from a swimming pool or to “pump out” flooded basements.

Table 1—Ejector versus suction/drafting performance characteristics.

	Ejector Drafting	Suction Drafting
Hose type	Cotton-synthetic rubber-lined hose	Semirigid hose
Amount of lift	0 to greater than 22 ft	Limited to 0 to 22 ft
Hose length	Up to 300 ft	Limited to 24 ft
Flow rate	Up to 2½ times the capacity of of the pump	Limited to the capacity of the of the pump
Affected by minor leaks	Loss in flow rate	Can ruin pump
Affected by hose kinks	Loss in flow rate	Pump damage

EJECTOR FIELD TEST PROCEDURE

Field testing was conducted to assess ejector performance with engine use. Performance curves were generated using data and water pickup units that were determined for lifts of 0 to 80 ft and pump discharge pressures of 25 to 250 psi. Field ejector testing consisted of preparing a hose loop from a U.S. Department of Agriculture (USDA) Forest Service Model 62 engine to the ejector at a water source (figure 2). All hose used during the test was 1-in and 1½-in cotton-synthetic hose constructed in accordance with Forest Service Specification 5100-186b.

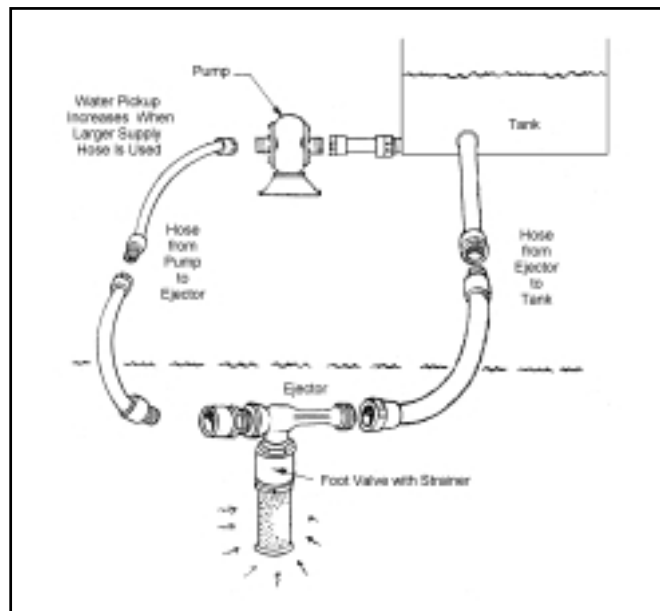

Figure 2—Ejector setup from the engine to water source and return.

A supply hose from the pump discharge to the inlet of the ejector was put down. The return hose was 1½ in. in diameter and was laid from the discharge side of the ejector back to the engine tank's inlet. Hose length was extended to achieve the lifts and slope distances required. Ejectors were tested with a foot valve strainer on the suction side. Hose clamps were used when changing ejectors to minimize water loss.

The ejector was submerged approximately 1 ft below the surface of the water. Pump discharge pressure was controlled at the engine from 50 to 250 psi, in 50 psi increments. Supply-line flow rate and pressure were measured at the engine pump discharge. Return-line flow rate and pressure were measured with a portable gauge and flowmeter. Measurements were obtained with both the 1-in hose and 1½-in discharge hose. Each ejector was tested at 0-, 17-, 25-, 32-, 40-, 53-, and 60-ft lifts. Ejectors with 2½-in discharge hoses were tested with a 0- and 25-ft lift only. Performance curves were generated from data, as indicated in appendix A.

EJECTOR PERFORMANCE MAPPING

Ejector performance was mapped in the laboratory to determine specific flow rates across the ejector. Optimum water pickup versus effectiveness across the ejector was determined. See figure 3 and appendix B. Mapping ejector performance provided the following information: ejector inlet pressure, ejector discharge pressure, pump discharge flow rate, and return-to-tank flow rate. This information was collected by laying two 40-ft lengths of cotton-synthetic hose between the engine and the ejector as supply and return. Flowmeters were positioned in line with the pump discharge and water return. Pressure gauges were located 5 diameters upstream from the ejector and 10 diameters downstream. Engine pump discharge pressure was measured at increments of 50 psi in a range between 0 and 250 psi. Pump discharge pressure, ejector inlet pressure, ejector discharge pressure, pump discharge flow rate, and return-to-tank flow-rate values were recorded.



Figure 3—Positioning ejector test setup for dropping into well.

EJECTOR SELECTION

When selecting the ejector, consider the end use. Each ejector has different performance capabilities, such as lift potential and flow rate. Review the ejector performance curves and comparison table in appendixes A, B, and C. See appendix A for ejector performance with engine use.

Ejector performance was mapped in the laboratory. Optimum water pickup versus effectiveness across the ejector was determined. See appendix B.

An ejector water pickup comparison table was developed from the data and listed in order of greatest to least water pickup at 150 psi for a 40-ft lift. All associated data for lifts of 0 to 80 ft and 25- to 250-psi pump discharge pressure is indicated. See appendix C.

Water Ejectors for Use in Wildland Firefighting

EJECTOR SETUP

Ejector setup consists of laying supply and return hose lines from the engine pump discharge to the water source and back to the tank. Use cotton-synthetic hose due to reduced friction loss characteristics. See figure 2. The following is recommended with use of ejectors:

- A spring-loaded foot valve strainer is important in an ejector drafting operation. Since the ejector hose lay must be charged to work, sufficient water must be available to fill the hose and to initiate water return to the tank. Consequently, it is highly desirable that once the hose is filled, water not be lost due to engine stops or repeated engine refills at one location. The check valve on the foot valve, attached to the suction side of the ejector, will prohibit loss of any water. However, a gravity type of foot valve is not recommended, as it will not always be in a position to be closed by gravity. The standard GSA foot valve is spring loaded.
- Protect the pump from sucking sand, silt, or gravel by using a foot valve strainer, positioned in a pail or on a shovel. This lifts the strainer away from the bottom of the water source, reducing silt and debris pickup. A clogged or blocked strainer can significantly decrease the efficiency of the water ejector.
- Caution: Reserve tank water. Sufficient reserve water must be left in the tank to prime/charge the ejector hose lay. Engines typically reserve a minimum of 20 percent of the tank capacity. For example, a Model 62 with a 500-gal tank will take action to refill when the tank level is down to 100 gal. This is a good practice for many reasons, but the primary reason is to maintain fire readiness and safety at all times. Also, when the tank water level is low, a minimum amount of water is necessary to prime the line. The minimum amount of water necessary to fill each 100 ft of 1-in-diameter hose is 4.1 gal. A 1½-in-diameter hose requires 9.2 gal and a 2½-in-diameter hose requires 25.5 gal.
- For best results and trouble-free operation, submerge the ejector at least 1 ft under water. Water pickup is also affected by failing to submerge the ejector sufficiently. The vacuum developed by the ejector can cause a whirlpool effect. This reduces water pickup and may allow air to be sucked into the combined flow. The solution is to submerge the ejector more deeply or to reduce pump discharge pressure.

EXAMPLES OF EJECTOR USE

Example 1. Fires close to a natural water source can be fought with a combination of water from the engine's water tank and the water source, extending the water available to pump. Ejector water can be returned to the water tank or used immediately (figure 4).



Figure 4—Ejector drafting operation to support fire suppression and maintain a full tank.

Example 2. Water sources that are normally inaccessible to suction drafting operations due to high lift, terrain, fences, or other obstructions can be used (figure 5).



Figure 5—Ejector drafting operation at a lift greater than 22 ft.

Example 3. Ejector drafting operations can be set up to use a variety of water sources, including swimming pools (figure 6).

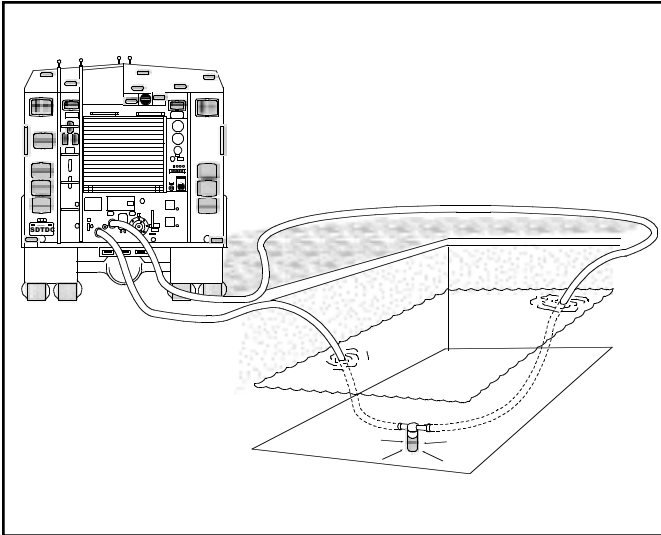

Figure 6—Ejector use from the street to a backyard swimming pool.

Example 4. Water can be lifted from rivers and creeks at bridge crossings, even if the water level is 100 ft below the roadbed. As the combined weight of hose, water, foot valve, and ejector is substantial, it is important to secure the supply and return hose lines to the engine with ropes. This minimizes the stress/loading on engine connections and fittings. In addition, the hose would be difficult to retrieve in the event that the coupling separated at both the discharge and return (figure 7).

An easy method to drain the lines and retrieve ejector hardware from a completed bridge ejector operation follows:

1. Ensure that the supply line is secured to the engine.
2. Disconnect the return line.
3. Drop the return line into the water away from obstacles that may impede recovery of the ejector setup.
4. Relieve suction by disconnecting the supply line from the pump. Again ensure that the supply line is always tied to the engine.
5. Lift the hose and ejector setup. The excess water will drain from the hose as it is lifted.



Figure 7—Ejector operation from a bridge.

Example 5. Rivers and lakes up to 300 ft from the road are readily available for tank refill with the use of an ejector (figure 8).



Figure 8—Ejector drafting operation at a sloped distance of 300 ft and vertical lift of 53 ft.

Example 6. A water ejector can remain set up as a water-filling station. Disconnect the supply and return the hose from the engine while operators are absent. Refill as often as necessary or until the water source is depleted. A foot valve strainer will act as a stopper to minimize hose water loss.

Water Ejectors for Use in Wildland Firefighting

In addition, the presence of soft ground can prevent a fire engine from positioning within suction-drafting distance to a water source. An ejector drafting operation can be set up on firmer ground up to 300 ft away from a shoreline (figure 9).



Figure 9—Water ejector setup for use as a water filling station and on soft ground.

Example 7. A large engine becomes a super-large engine under ordinary drafting conditions. By using an ejector, an engine can fill the tank at a rate equal to two times the output. Dirty, sand-laden water can be utilized to put out fires, and up to two times the engine capacity can be applied since none of the dirty water passes through the pump. An ejector can be used to draft water to refill the primary tank, the mother tanks, or both at the same time. (figure 10).

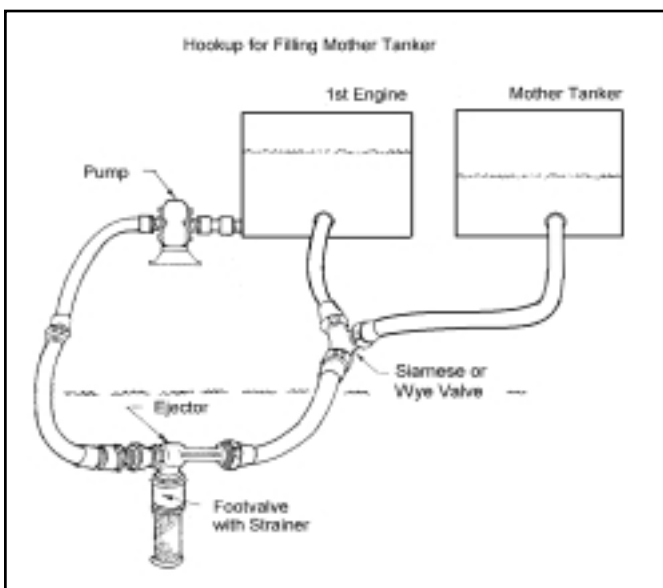

Figure 10—Ejector drafting operation for refilling the primary and mother tanks simultaneously.

Example 8. Ejectors can be used in a variety of lifts and line lengths (figure 11).

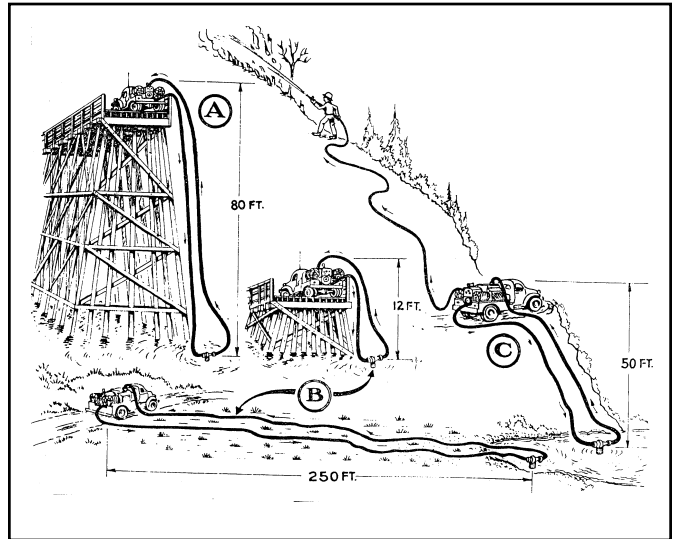

Figure 11—Ejectors are designed for different uses: (a) high lift, (b) low lift, and (c) moderate lift with long lines.

Example 9. Ejectors can be used to draft water from a well with only the suction side submerged. This type of drafting operation should be used only when absolutely necessary. This is a combined/modified suction-drafting operation, so fittings must be tight with no leaks. The height the water can be lifted is considerably reduced by each foot added to the suction lift (figure 12).

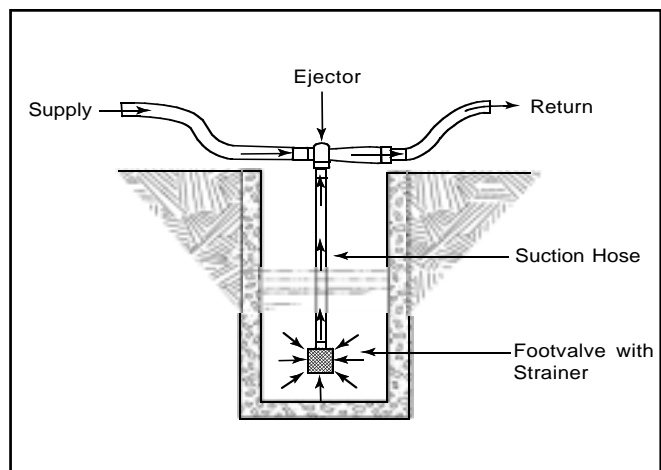

Figure 12—Ejectors can be used to draft water from a well.

FRICION LOSS

Friction loss is an important consideration when determining the hose diameter of the supply and return lines. Friction loss results from the resistance created by water moving along the inside wall of the hose or through appliances. When practicable, minimize the

distance between the engine and the water source to reduce friction loss, which will maximize lift and drafting capabilities. Long hose lays can significantly reduce water pickup. Use the shortest possible hose lay, and remove kinks or sharp bends. Friction loss per 100 ft of hose has been determined for all hose used in wildland firefighting. Appendix D indicates that, typically, cotton-synthetic hose has a lower friction loss than all-synthetic hose, and consequently, cotton-synthetic hose is recommended in ejector drafting operations.

There are several key points to remember regarding friction loss:

- Friction loss increases as flow increases.
- Total friction loss varies with the length of the hose lay. Do not use a longer hose lay than necessary.
- Friction loss for reeled hose is approximately 21 percent more than for straight hose lays.
- Friction loss varies with type, age, and quality of hose.
- The smaller the hose diameter, the greater the friction loss. Reducing the hose diameter by one half increases the friction loss by a factor of four.
- The larger the hose diameter, the lower the friction loss. Doubling the hose diameter reduces the friction loss to one-quarter of the original value.
- A 1-in hose lay has about six times the friction loss of a 1½-in hose lay.

DUAL RETURN LINES TO OPTIMIZE LIFT CAPACITY

Friction loss compromises lift capacity. Lift capacity is reduced by 2.3 ft for every 1-psi loss. This can be addressed by setting up dual return lines. The ejector data in appendix A for 1½-in-diameter ejectors were collected with 1½-in diameter, 100-ft cotton-synthetic hose on the supply and return lines. Ejector data for 2½-in-diameter ejectors were collected with 1½-in-diameter, 40-ft cotton-synthetic hose on the supply line and 2½-in diameter, 35-ft hose on the return line. This data is represented in the performance graphs in appendixes A and C. See the friction loss data in appendix D.

Use caution before choosing a 2½-in ejector to obtain the high water-pickup flow rates indicated in tables A8 and A9. Using 2½-in ejectors requires carrying enough 2½-in hose to support ejector-drafting operations. If

1½-in hose is used in lieu of 2½-in hose on the return, the friction loss will increase exponentially, significantly increasing head loss, reducing lift, and compromising ejector-drafting capabilities, negating any gain from using a larger ejector.

This increase in friction loss can be addressed by using a wye and two lengths of hose to construct dual return lines back to the tank. See figure 13. This will decrease the flow rate in the hose by one-half (as there are two lines), which will decrease the friction loss, resulting in a head gain, increased lift, and improved drafting capabilities. The performance curves in appendix A and the friction loss table in appendix D provide data for selecting the best ejector and hose diameter for the ejector operation. This is best explained by use of practical examples.

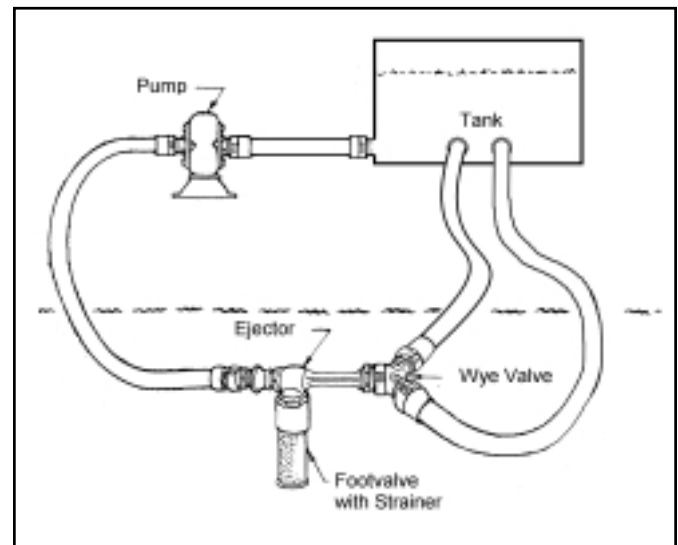

Figure 13—Friction loss is reduced by using dual return lines.

Reference ejector performance data is shown in figure A-4 for the Penberthy 1½ LM ejector. This graph indicates that at 250 psi, a minimum flow rate of 56 gpm is required to begin operating at a 40 ft lift, with an expected maximum return flow of 85 gpm. However, the slope distance is observed to be around 200 ft. All 1½-in-ejector performance curves include friction loss for 100-ft hose, so the friction loss for another length of 1½-in cotton-synthetic hose must be added. See table D1. For example, when using 1½-in National cotton-synthetic hose, the friction loss value at 85 gpm for this hose equals 25 psi or a 58-ft loss in lift capacity. However, setting up a dual return line will reduce return flow to 42 gpm and friction loss to 5 psi in each line. This friction loss of 5 psi correlates to a 12-ft loss in lift capacity, as a 1-psi loss in pressure correlates to a loss in lift capacity of 2.3 ft.

Water Ejectors for Use in Wildland Firefighting

The ejector mapping data in appendix B, table B1 shows that the Penberthy 1½ LL at 0 lift with an engine discharge pressure of 150 psi, has an ejector inlet flow rate of 30 gpm, a discharge flow rate of 70 gpm, and a water pickup of 40 gpm. This is the optimum engine pressure versus water pickup flow rate for this ejector. To set up this ejector operation, 100 ft of hose is necessary. The friction loss table in appendix D indicates that, in general, cotton-synthetic hose has a lower friction loss than all-synthetic hose. Friction loss for a 100-ft length of 1½-in-diameter National 186 cotton-synthetic hose at a flow of 70 gpm results in a friction loss of 17 psi for every length of 100 ft. This 17-psi loss converts to a loss of 39-ft lift. The engine pressure could be reduced to 100 psi with a resultant

decrease in discharge flow from 70 gpm to 59 gpm, reducing friction loss to 12-psi, or 28-ft lift loss. However, water pickup is decreased from 40 gpm to 34 gpm.

A better method to address friction loss in the return line and optimize lift capacity is to set up a wye with dual return lines, so the 70 gpm return flow is accommodated by two lines at 35 gpm each, reducing friction loss to 4 psi (9-ft lift) and improving lift capability and effectiveness of the ejector-drafting operation.

EJECTOR TROUBLESHOOTING

Table 2 provides some practical information for addressing problems when using ejectors.

Table 2—Ejector troubleshooting.

Problem	Remedy
1. Friction losses in hose, caused by an overly small hose, can negate the value of using an ejector.	Use a hose size as large or larger than the size recommended in this document.
2. Kinks in the return line can cause failure because pressure from the ejector outlet is limited. Keep the return line straight, especially at the ejector connection and where it empties into the tank.	Keep the return line straight, especially at the ejector connection and where it empties into the tank.
3. Dirt and sand can be picked up and brought back to the tank.	Fix a shovel or a pail to the ejector foot valve strainer to elevate it above the bottom.
4. If the ejector is not submerged sufficiently, an air funnel can develop, causing the ejector to suck air instead of water.	Submerge the suction end of the ejector at least 12 in, if possible.
5. When using an ejector that is one-half the volume of the engine's pump and when pumping directly onto a fire, sufficient pressure may not be available to lift water to the tank. This could happen if a large nozzle tip is attached on the discharge line and only a short hose lay is used.	Use a smaller tip on the nozzle, or partially close the shutoff nozzle on the hose. Another solution is for the engine operator to close down the valve on the discharge line until proper pressure is attained. After the tank is full, the water-feeding ejector can be shut off and the entire tank discharged on the fire until the water level becomes low. The water-feeding ejector is then opened again to fill the tank.
6. Water drains from hose lines if the engine stops. A reserve supply of water is necessary before ejector action can be restarted.	Inspect the foot valve on the suction side of the ejector.
7. The water recirculates with no water pickup, which is indicated by a constant water level in the tank.	Ejector may be turned backwards. The foot valve shuts tight due to the pressure, and the water recirculates. Disconnect, reposition, and reconnect.

EJECTOR SPECIFICATIONS AND DESCRIPTIONS

A detailed description for each ejector and the necessary fire hose connections and fittings required is provided in appendix E. Weight, cost, dimensions, and material are included.

Ejector Manufacturer Information

Cascade Fire Equipment Company
P.O. Box 4248
Medford, OR97501
Telephone: 800-654-7049 Fax: 541-779-8847
Web site: <http://www.cascadefire.com>

Cascade Ejector Model No. 14726 is available through GSA on Federal Supply Schedule 42, Part b.
Penberthy, Inc.
322 Locust Street
Prophetstown, IL61277
Telephone: 815-537-2311 Fax: 815-537-5764
Web site: <http://www.penberthy-online.com>

Penberthy ejectors are sold through distributors. Contact Penberthy directly for a local distributor. Prices may vary.

RELATED PUBLICATIONS

National Wildfire Coordinating Group. 1994. Water handling equipment guide. NFES 1275, PMS 447-1.

National Wildfire Coordinating Group. 1997. Wildland fire hose guide. NFES 1308, PMS 466.

Forest Service Specification 5100-186, "Fire Hose, Cotton-Synthetic, Lined, Woven Jacket, 1 inch and 1½ inch."

Forest Service Specification 5100-187, "Fire Hose, Lightweight Synthetic, Lined, Woven Jacket, 1 inch and 1½ inch."

APPENDIX A

Ejector Performance Charts

Ejector Performance Charts

Each ejector has different performance characteristics. For each ejector the pump discharge pressure versus the pump discharge flow rate and the return-to-tank flow rate were plotted on performance graphs. See the following figures. The curve labeled “Pump Discharge” is the minimum flow rate required by the ejector to produce enough suction to begin water pickup. The curve labeled “Return to Tank” is the amount of water discharged from the ejector to the tank. Water pickup is the flow of “Return to Tank” minus “Pump Discharge.” This is the amount of water picked up by the suction developed by the venturi and nozzle of the ejector. Water pickup is indicated by the gray shaded area. These ejector performance charts are best explained by the following series of questions as referenced by figure A, Penberthy 1½ LM ejector performance curves:

An engine is positioned 40 vertical ft above the water source. The crew will use a Penberthy 1½ LM ejector to pick up water to refill the tank. Crew members will use 100 ft of 1½-in cotton-synthetic hose on the supply and return lines. They will use a foot valve.

Question 1. At 175 psi, what is the minimum flow rate needed to operate this ejector?

Solution Method: Find 175 psi on the pressure axis at (1). Follow the 175-psi line to the intersection of the curve labeled “Pump Discharge” (2). Move to the left of the intersection to the flow rate axis. Read the value off the flow axis as 47 gpm.

Answer: The minimum flow rate for this ejector to pick up water at 175 psi is 47 gpm.

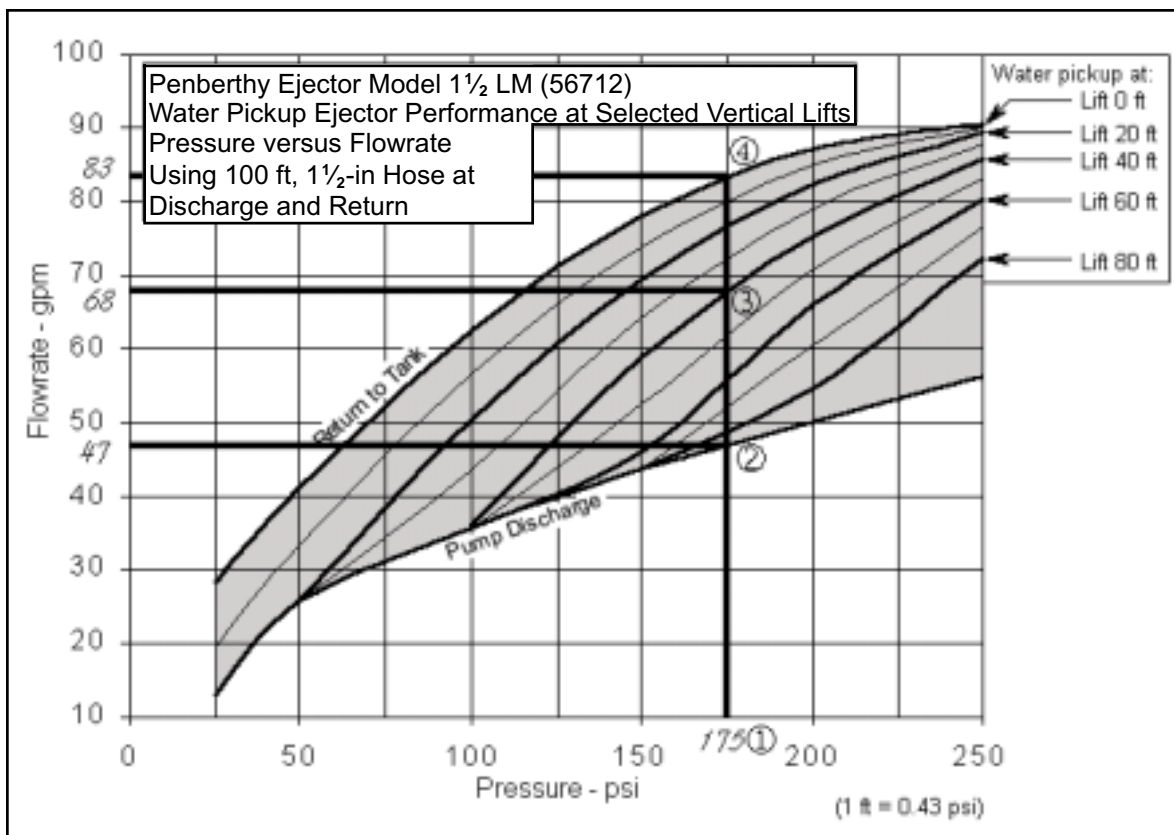

Figure A—Ejector exercise example for discussion.

Appendix A

Question 2. At 175 psi and 40-ft lift, how much water/flow is returned to the tank?

Solution Method: Find 175 psi on the pressure axis (1). Follow the 175-psi line to the intersection of the curve labeled "Pump Discharge" (2). Continue up to the curve labeled "Water Pickup at Lift 40 ft" (3). Move left and read the value off the flow axis as 68 gpm.

Answer: At 175 psi and with a 40-ft lift, 68-gpm water/flow is returned to the tank.

Question 3. How much water is picked up at 175 psi with a 40-ft lift?

Solution Method: Follow the previous method. At 175 psi (1) off the pressure axis, we know that 47 gpm is needed to cause the ejector to begin the suction operation (2). This is also the pump discharge flow rate or the input into the ejector. Continue up the 175-psi line to a 40-ft lift (3), where we know that the amount of water returned to the tank is 68 gpm. The gray area is the water pickup, so subtract the pump discharge 47 gpm from the return to the tank to equal 68 gpm; resulting in a water pickup of 21 gpm.

Answer: With this ejector at 175 psi at a 40-ft lift, 21 gpm of water is picked up.

Question 4. What is the maximum flow rate at 175 psi?

Solution Method: The maximum flow rate will occur at 0-ft lift. Find 175 psi on the pressure axis at (1). Follow the 175 psi line through the intersection of the curve labeled "Pump Discharge," up to lift at 0 ft. (4). Move to the left of this intersection and read the value off the flow axis as 83 gpm.

Answer: The maximum flow rate for this ejector at 175 psi, to pick up water at 0-ft lift, is 83 gpm.

Question 5. What is the maximum water pickup at 175 psi?

Solution Method: Follow the previous method. With a pump discharge pressure of 175 psi, at 0-ft lift, the pump discharge flow is 47 gpm, and the return to the tank is 83 gpm. Calculate the difference of the water pickup or 83 minus 47 gpm, which equals 36 gpm.

Answer: The maximum water pickup for this ejector at 175 psi, to pick up water at 0-ft lift, is 36 gpm.

Penberthy Ejector

Model 1¼ LL (56711)

American National Fire Hose Connection Screw Thread (NH)

National Pipe Thread (NPT)

¾ NH by 1½ NPT by 1½ NPT

Material: Cast Iron Wt: 2.5 lb

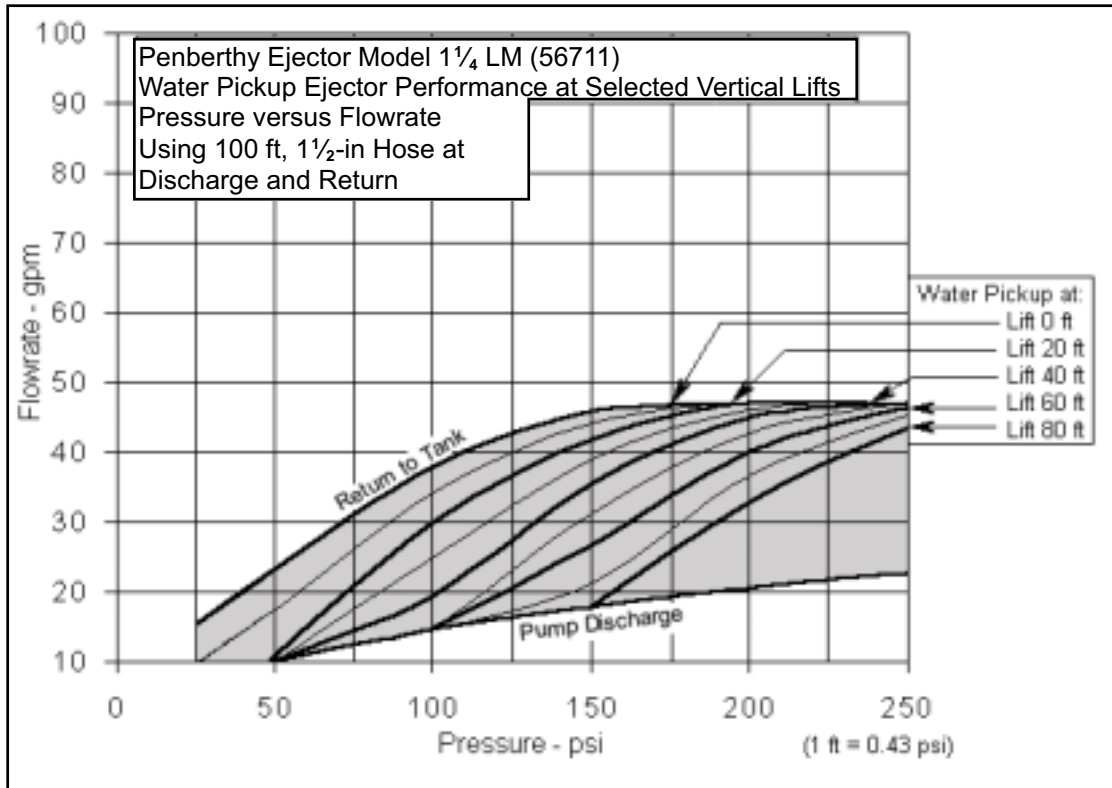
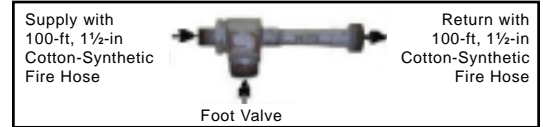

Figure A1—Penberthy Model 1¼ LL (56711) water pickup ejector performance graph.

Table A1—Penberthy Model 1¼ LL (56711) water pickup ejector performance table of values.

Supplied Pressure psi	Pump Discharge gpm	Water Pickup at Selected Vertical Lifts with 100-ft, 1½-in Cotton-Synthetic Fire Hose for Supply and Discharge				
		0 ft gpm	20 ft gpm	40 ft gpm	60 ft gpm	80 ft gpm
25	8	7	~	~	~	~
50	10	14	4	~	~	~
100	15	22	15	6	~	~
150	18	27	23	17	9	~
200	20	29	27	24	18	12
250	23	26	27	26	24	20

Appendix A

Cascade Ejector Model 14726

National Pipe Standard Hose (NPSH)
American National Fire Hose Connection Screw Thread (NH)
1 NPSH by 1½ NH by 1½ NH
Material: Cast Aluminum Alloy Wt: 1.2 lb

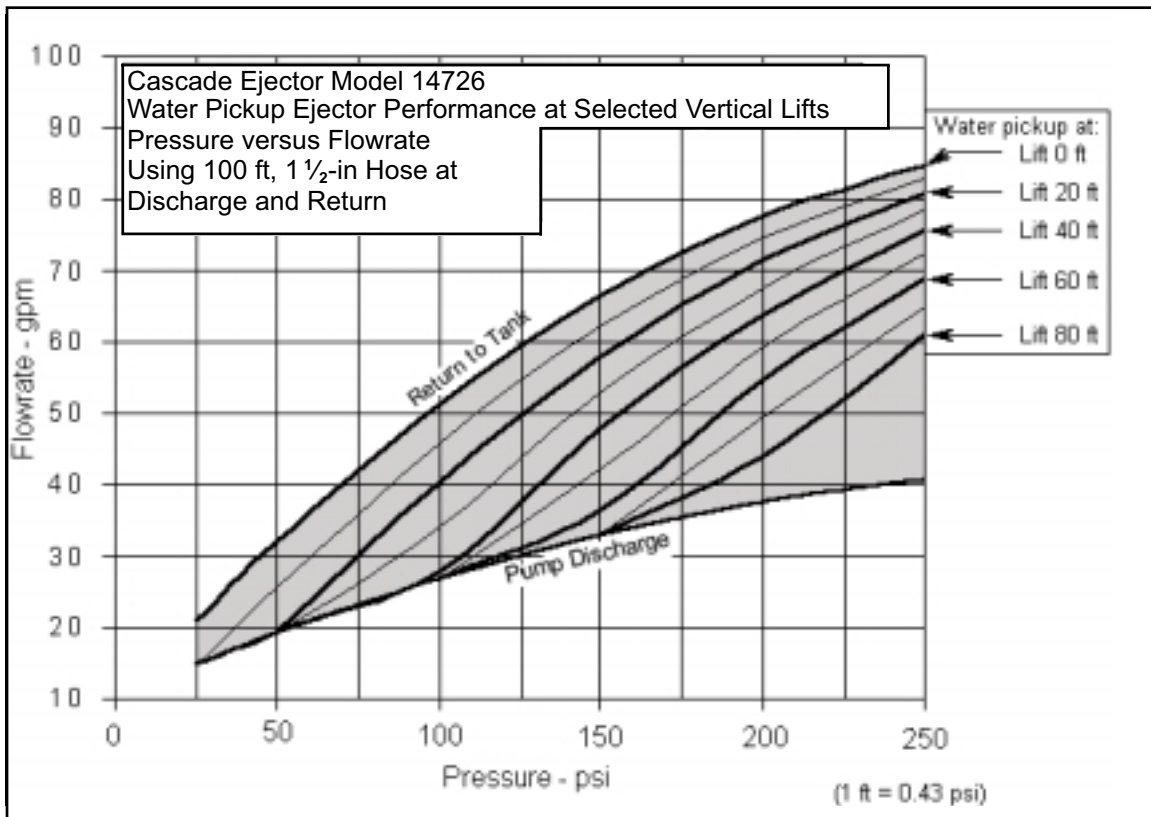
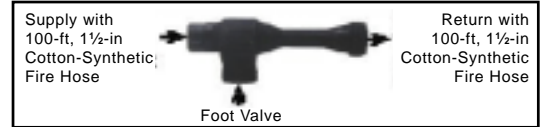

Figure A2—Cascade Model 14726 water pickup ejector performance graph.

Table A2—Cascade Model 14726 water pickup ejector performance table of values.

Pump Discharge Pressure psi	Pump Discharge Flow gpm	Water Pickup at Selected Vertical Lifts with 100-ft, 1½-in Cotton-Synthetic Fire Hose for Supply and Discharge				
		0 ft gpm	20 ft gpm	40 ft gpm	60 ft gpm	80 ft gpm
25	15	6	~	~	~	~
50	19	13	~	~	~	~
100	27	24	13	1	~	~
150	33	33	25	15	3	~
200	38	40	34	26	17	6
250	41	44	40	35	28	20

Penberthy Ejector

Model 1½ LL (56712)

National Pipe Thread (NPT)

National Pipe Standard Hose (NPSH)

1½ NPT by 1½ NPSH by 1½ NPSH

Material: Cast Iron Wt: 3.5 lb

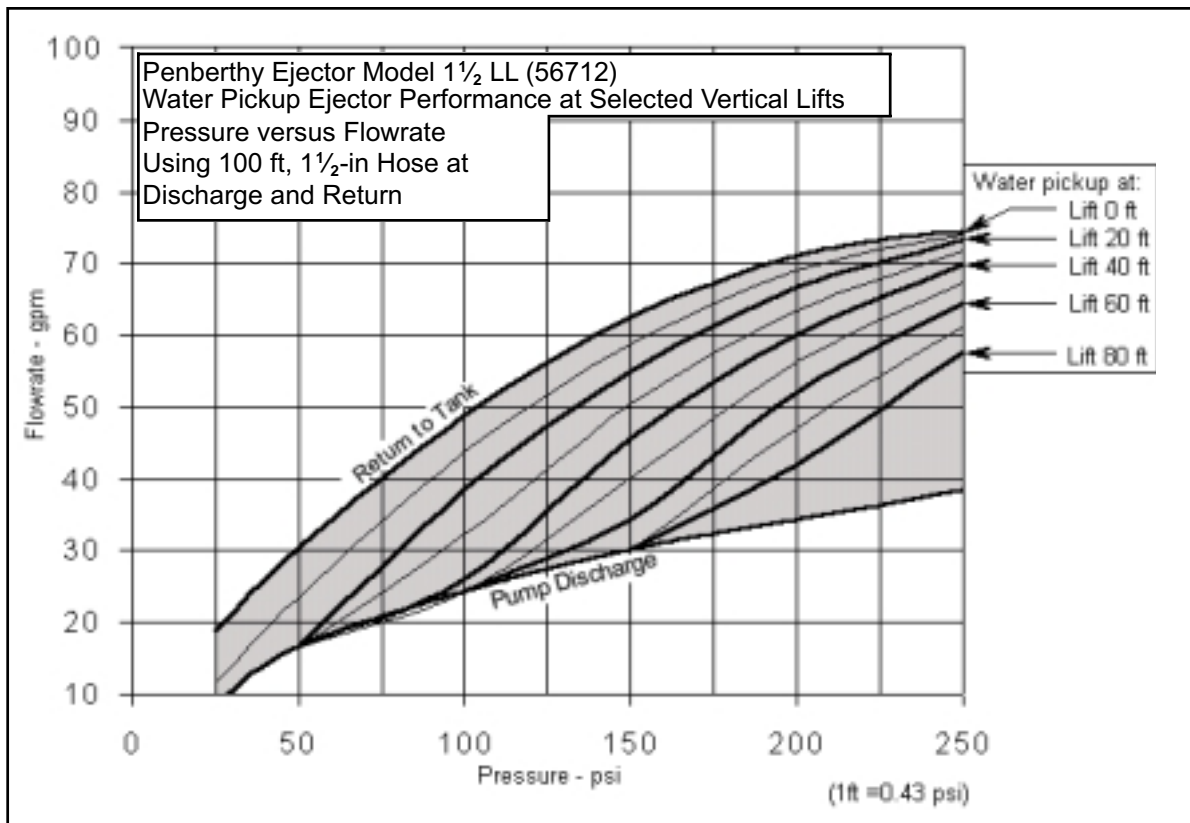
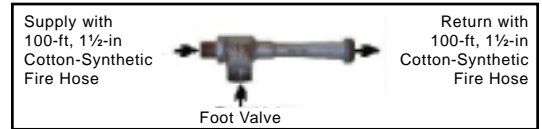

Figure A3—Penberthy Model 1½ LL (56712) water pickup ejector performance graph.

Table A3—Penberthy Model 1½ LL (56712) water pickup ejector performance table of values.

Supplied Pressure psi	Pump Discharge gpm	Water Pickup at Selected Vertical Lifts with 100-ft, 1½-in Cotton-Synthetic Fire Hose for Supply and Discharge				
		0 ft gpm	20 ft gpm	40 ft gpm	60 ft gpm	80 ft gpm
25	9	10	~	~	~	~
50	17	14	~	~	~	~
100	24	25	14	2	~	~
150	30	32	25	15	4	~
200	34	37	32	26	18	8
250	38	36	35	31	26	19

Appendix A

Penberthy Ejector

Model 1½ LM (56712)

National Pipe Thread (NPT)

National Pipe Standard Hose (NPSH)

1½ NPT by 1½ NPSH by 1½ NPSH

Material: Cast Iron Wt: 3.5 lb

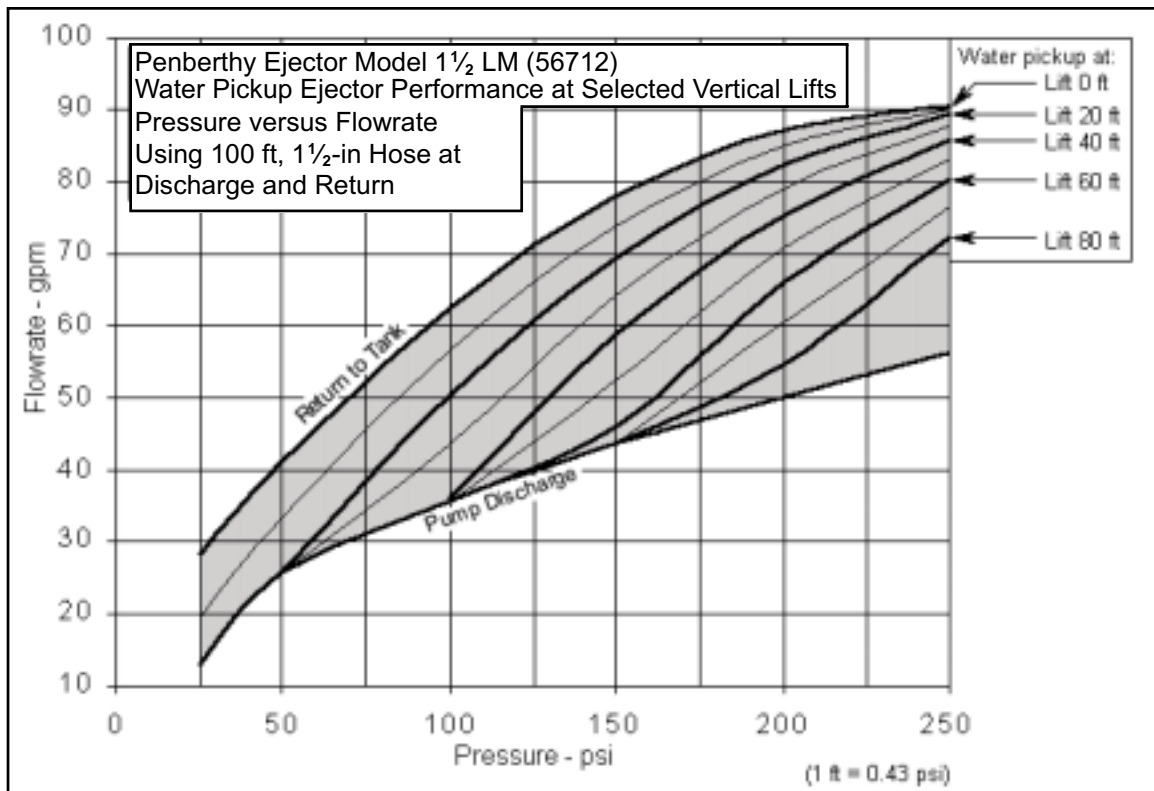
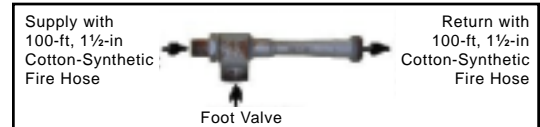

Figure A4—Penberthy Model 1½ LM (56712) water pickup ejector performance graph.

Table A4—Penberthy Model 1½ LM (56712) water pickup ejector performance table of values.

Supplied Pressure psi	Pump Discharge gpm	Water Pickup at Selected Vertical Lifts with 100-ft, 1½-in Cotton-Synthetic Fire Hose for Supply and Discharge				
		0 ft gpm	20 ft gpm	40 ft gpm	60 ft gpm	80 ft gpm
25	13	15	~	~	~	~
50	26	15	~	~	~	~
100	36	27	15	~	~	~
150	44	34	26	15	2	~
200	50	37	32	25	16	5
250	56	34	33	30	24	16

**Penberthy Ejector
Model 1¼ LM (56711)**

National Pipe Standard Hose (NPSH)
National Pipe Thread (NPT)
1 NPSH by 1½ NPT by 1½ NPT
Material: Cast Iron Wt: 2.6 lb

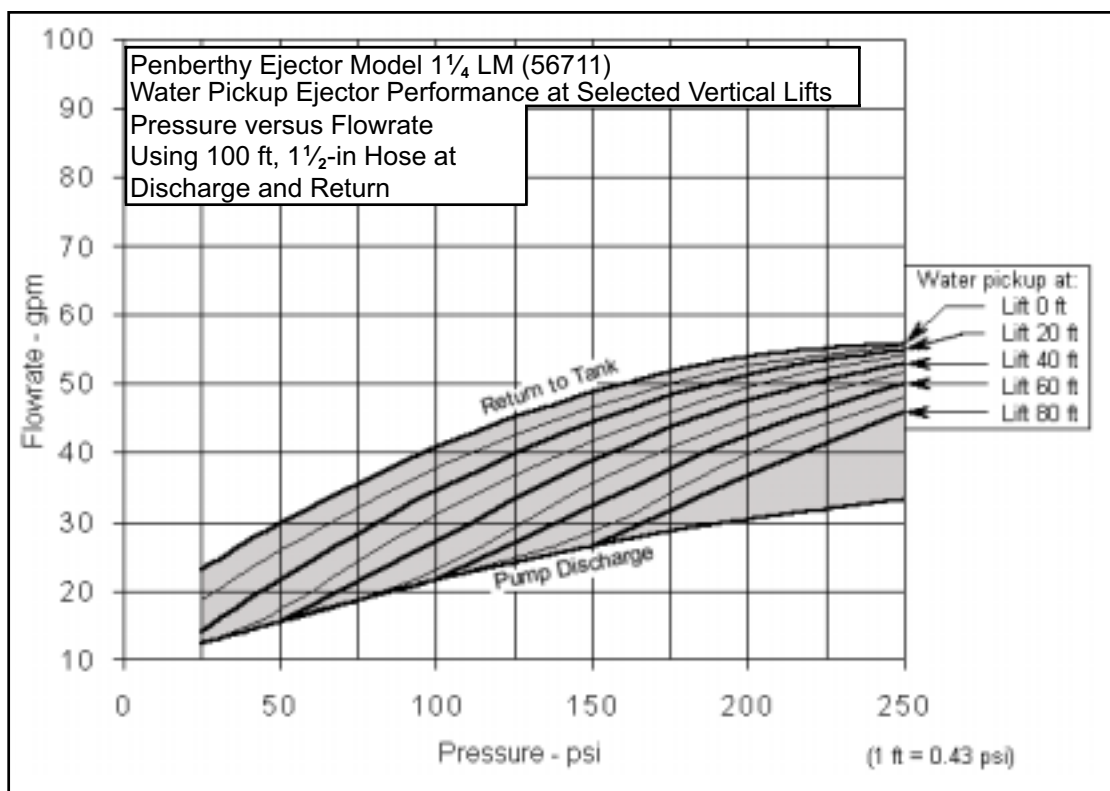

Figure A5—Penberthy Model 1¼ LM (56711) water pickup ejector performance graph.

Table A5—Penberthy Model 1¼ LM (56711) water pickup ejector performance table of values.

Supplied Pressure psi	Pump Discharge gpm	Water Pickup at Selected Vertical Lifts with 100-ft, 1½-in Cotton-Synthetic Fire Hose for Supply and Discharge				
		0 ft gpm	20 ft gpm	40 ft gpm	60 ft gpm	80 ft gpm
25	12	11	2	~	~	~
50	16	14	6	~	~	~
100	21	19	13	6	~	~
150	26	22	18	12	6	~
200	30	24	21	17	12	6
250	33	23	22	20	17	13

Appendix A

Penberthy Ejector

Model 1¼ LH (56711)

National Pipe Thread (NPT)

National Pipe Standard Hose (NPSH)

1 NPSH by 1½ NPT by 1½ NPT

Material: Bronze Wt: 3.1 lb

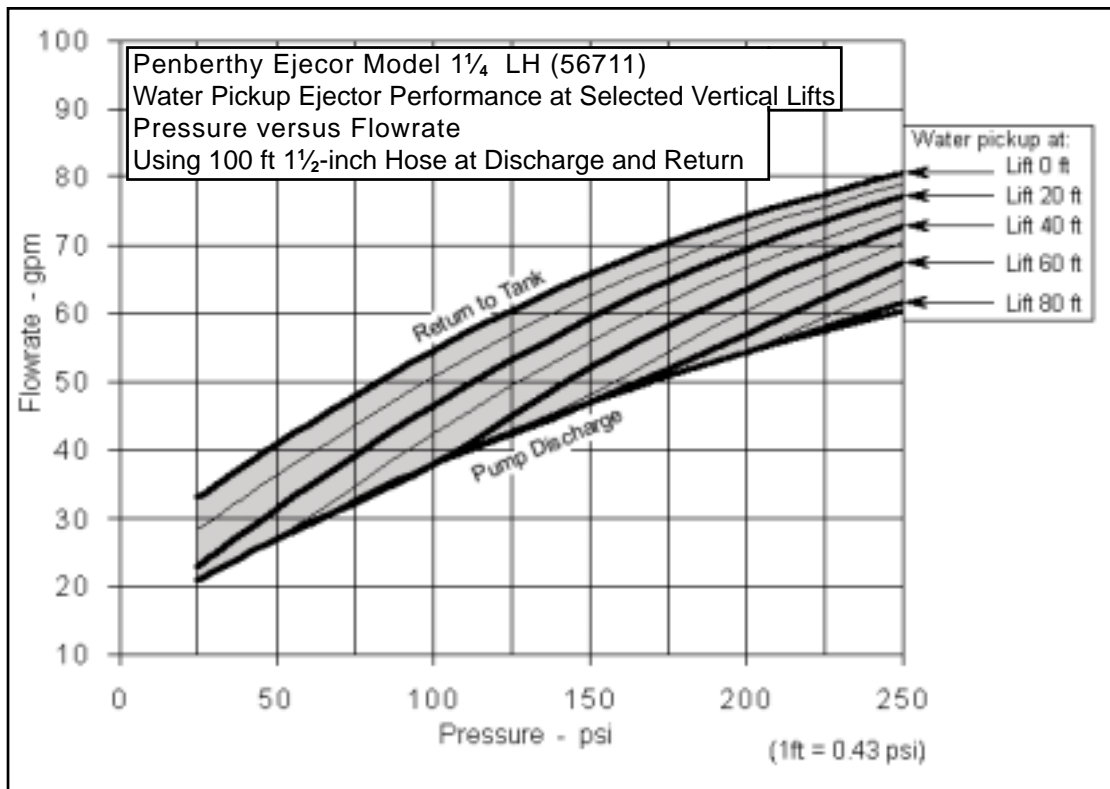
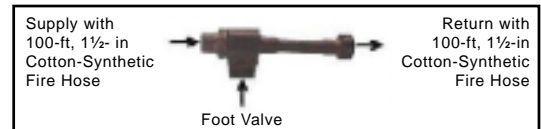

Figure A6—Penberthy Model 1¼ LH (56711) water pickup ejector performance graph.

Table A6—Penberthy Model 1¼ LH (56711) water pickup ejector performance table of values.

Supplied Pressure psi	Pump Discharge gpm	Water Pickup at Selected Vertical Lifts with 100-ft, 1½-in Cotton-Synthetic Fire Hose for Supply and Discharge				
		0 ft gpm	20 ft gpm	40 ft gpm	60 ft gpm	80 ft gpm
25	21	12	2	~	~	~
50	27	14	5	~	~	~
100	38	17	9	~	~	~
150	47	19	12	5	~	~
200	54	20	15	9	3	~
250	61	20	17	12	7	1

**Penberthy Ejector
Model 1½ LH (56712)**

National Pipe Thread (NPT)
National Pipe Standard Hose (NPSH)
1½ NPT by 1½ NPSH by 1½ NPSH
Material: Cast Iron Wt: 3.7 lb

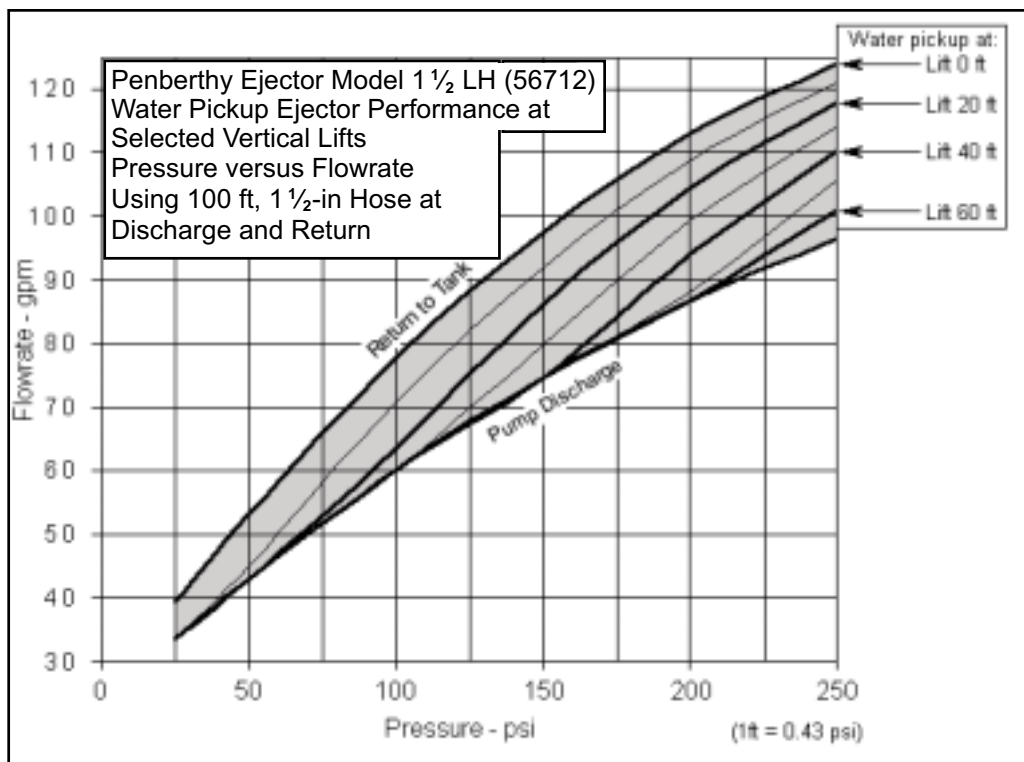
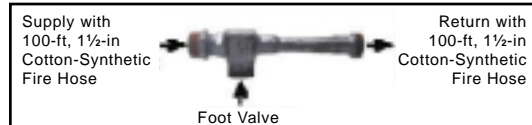

Figure A7—Penberthy Model 1½ LH (56712) water pickup ejector performance graph.

Table A7—Penberthy Model 1½ LH (56712) water pickup ejector performance table of values.

Supplied Pressure psi	Pump Discharge gpm	Water Pickup at Selected Vertical Lifts with 100-ft, 1½-in Cotton-Synthetic Fire Hose for Supply and Discharge				
		0 ft gpm	20 ft gpm	40 ft gpm	60 ft gpm	80 ft gpm
25	34	6	~	~	~	~
50	43	10	~	~	~	~
100	60	18	3	~	~	~
150	75	23	11	~	~	~
200	87	26	17	7	~	~
250	96	28	22	14	5	~

Appendix A

Penberthy Ejector

Model 2½ LH (56714)

National Pipe Standard Hose (NPSH)

American National Fire Hose Connection Screw Thread (NH)

2½ NPSH by 2½ NH by 2½ NH

Material: Cast Iron Wt: 11.0 lb

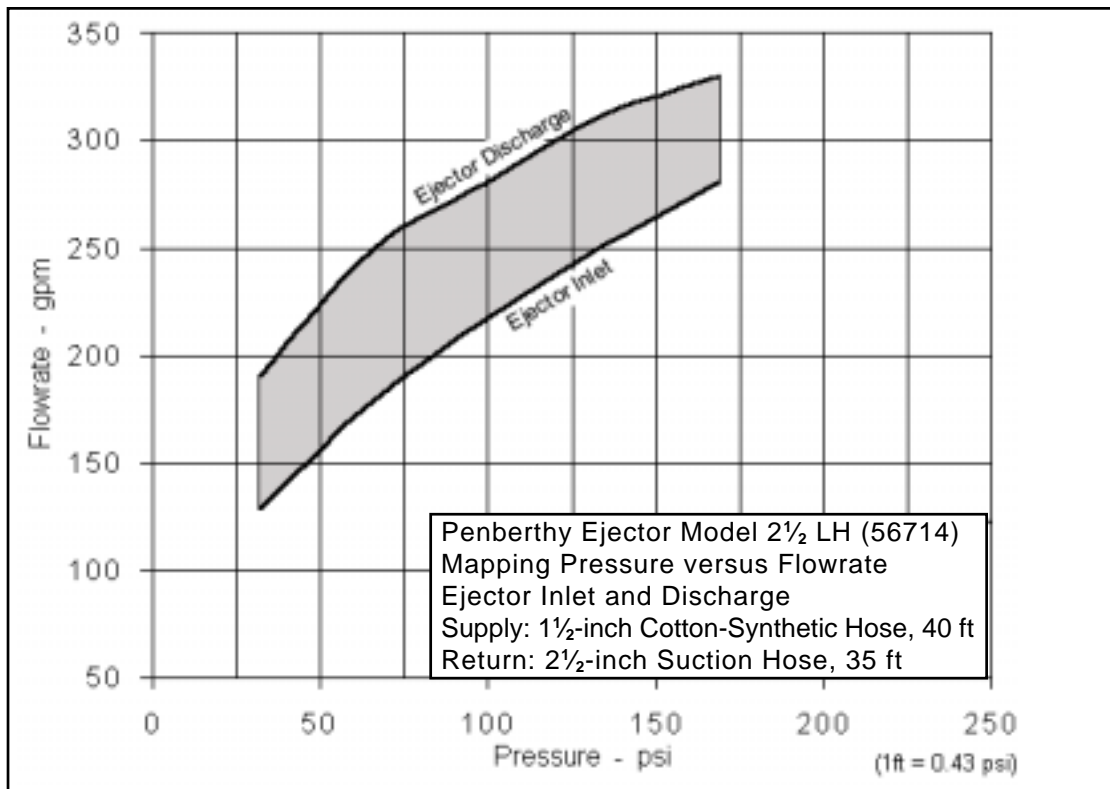

Figure A8—Penberthy Model 2½ LH (56714) mapping pressure versus flowrate graph.

Table A8—Penberthy Model 2½ LH (56714) mapping table of values.

Pump Discharge Pressure psi	Ejector Inlet		Ejector Discharge		Water Pickup	
	Pressure psi	Flow Rate gpm	Pressure psi	Flow Rate gpm	Flow Rate gpm	Effectiveness %
50	32	128	8	190	62	48
100	66	179	13	249	70	39
150	99	216	17	280	64	30
200	134	251	19	311	60	24
250	169	281	22	330	49	17

**Cascade Ejector
Model 14727**

American National Fire Hose Connection Screw Thread (NH)
1½ NH by 2½ NH by 2½ NH
Cast Aluminum Alloy Wt: 4.8 lb

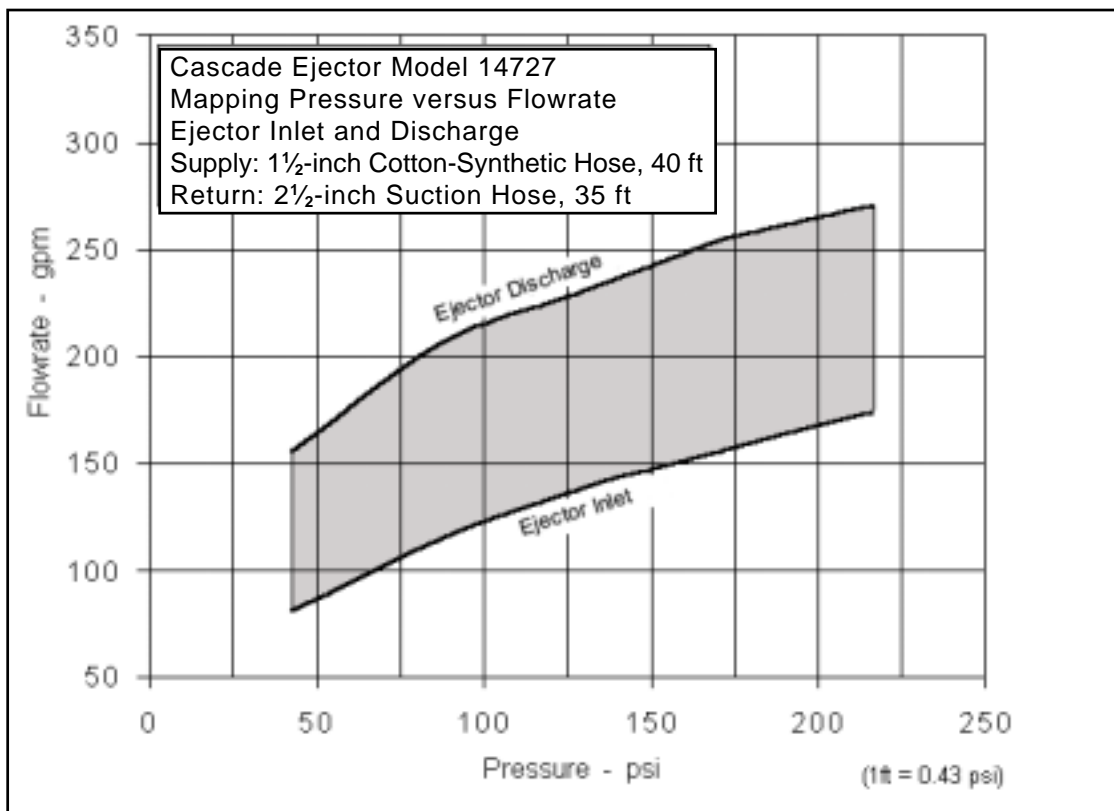
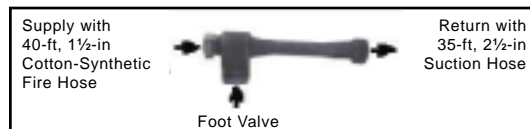

Figure A9—Cascade Ejector Model 14727 mapping pressure versus flow rate graph.

Table A9—Cascade Ejector Model 14727 mapping table of values.

Pump Discharge Pressure psi	Ejector Inlet		Ejector Discharge		Water Pickup	
	Pressure psi	Flow Rate gpm	Pressure psi	Flow Rate gpm	Flow Rate gpm	Effectiveness %
50	43	81	7	155	74	91
100	86	114	10	205	91	80
150	128	137	11	229	92	67
200	171	156	13	254	98	63
250	216	174	15	270	96	55

APPENDIX B

Mapping Ejector Performance Comparisons

Mapping Ejector Performance Comparisons

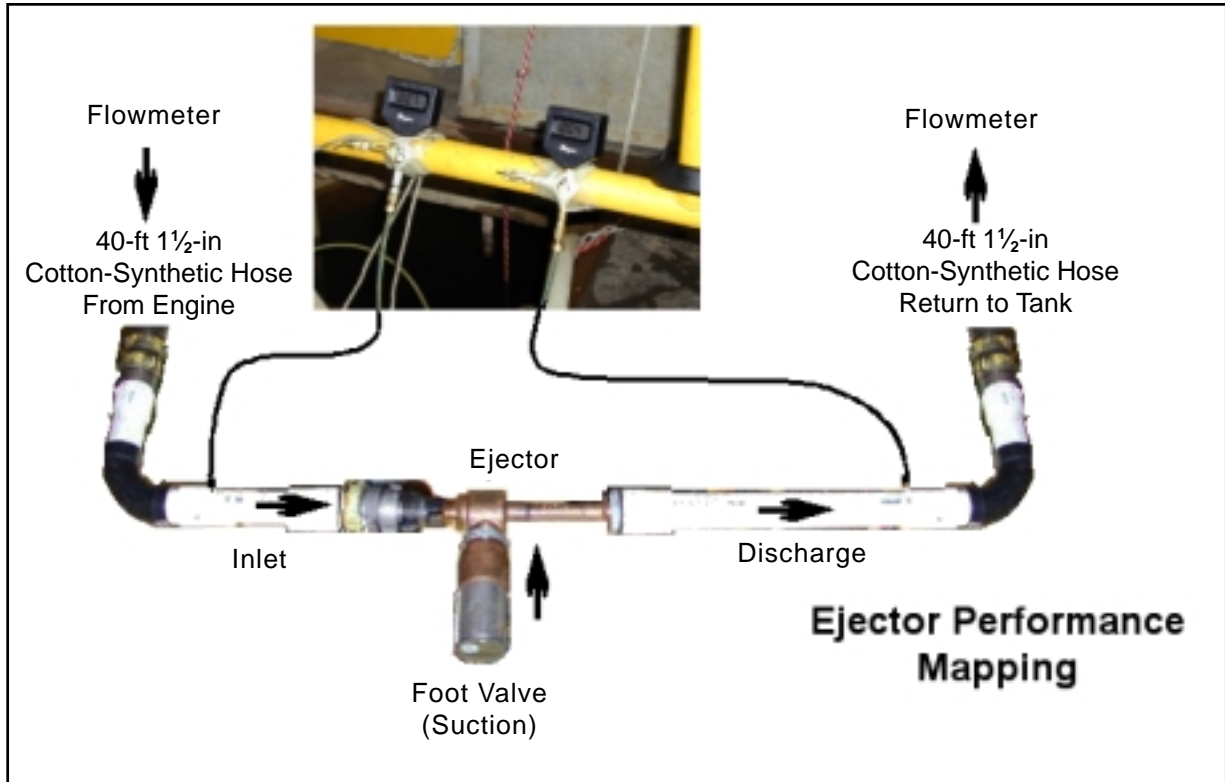

Figure B1—Equipment setup for mapping ejector performance.

Table B1—Mapping Ejector Performance, Table of Measured Values

Mapping Pressure and Flow Rate Across Ejector Inlet and Discharge

Elevation @ 0 feet; Pressure Tap Location: Upstream 5 diameters from ejector and 10 diameters downstream; ejectors are organized from greatest to least water pickup. Gray area is optimum water pickup versus effectiveness.

Brand Model	Engine Discharge Pressure psi	Ejector Inlet		Ejector Discharge		Water Pickup	
		pressure psi	flow rate gpm	pressure psi	flow rate gpm	flow rate gpm	effectiveness %
Penberthy 1¼ LL ¾ NH by 1½ NPT by 1½ NPT	50	50	10	4	22	12	120
	100	97	15	8	40	25	167
	150	148	18	8	42	24	133
	200	199	21	9	46	25	119
	250	249	24	8	46	22	92
Cascade 14726 1 NPSH by 1½ NH by 1½ NH	50	48	20	6	44	24	120
	100	99	28	10	68	40	143
	150	148	34	13	80	46	135
	200	198	39	15	85	46	118
	250	247	43	16	88	45	105

Appendix B

Table B1—Mapping Ejector Performance, Table of Measured Values (continued)

Brand Model	Engine Discharge Pressure psi	Ejector Inlet		Ejector Discharge		Water Pickup	
		pressure psi	flow rate gpm	pressure psi	flow rate gpm	flow rate gpm	effectiveness %
Penberthy 1½ LL 1½ NPT by 1½ NPSH by 1½ NPSH	50	50	18	7	37	19	106
	100	99	25	11	59	34	136
	150	147	30	19	70	40	133
	200	198	35	21	75	40	114
	250	247	39	23	78	39	100
Penberthy 1½ LM 1½ NPT by 1½ NPSH by 1½ NPSH	50	49	26	12	45	19	73
	100	98	37	20	70	33	89
	150	146	45	19	82	37	82
	200	194	52	20	89	37	71
	250	244	58	23	93	35	60
Penberthy 1¼ LM 1 NPSH by 1½ NPT by 1½ NPT	50	49	16	6	34	18	113
	100	98	22	8	47	25	114
	150	150	27	8	51	24	89
	200	198	31	9	55	24	77
	250	247	35	10	59	24	69
Penberthy 1¼ LH 1 NPSH by 1½ NPT by 1½ NPT	50	50	28	10	50	22	79
	100	100	40	11	62	22	55
	150	145	48	13	69	21	44
	200	195	56	15	78	22	39
	250	245	63	17	85	22	35
Penberthy 1½ LH 1½ NPT by 1½ NPSH by 1½ NPSH	50	46	44	17	57	13	30
	100	94	62	30	90	28	45
	150	142	76	37	106	30	39
	200	188	88	43	117	29	33
	250	237	99	30	125	26	26

American National Fire Hose Connection Screw Thread (NH); National Pipe Thread (NPT); National Pipe Standard Hose (NPSH)

Table B2—Mapping Ejector Performance, Table of Measured Values, 2½-in ejector

Mapping Pressure and Flow Rate Across Ejector Inlet and Discharge

Elevation@ 0 feet; Pressure Tap Location: Upstream 5 diameters from ejector and 10 diameters downstream; ejectors are organized from greatest to least water pickup. Gray area is optimum water pickup versus effectiveness.

Brand Model	Engine Pump Pressure psi	Ejector Inlet		Ejector Discharge		Water Pickup	
		pressure psi	flow rate gpm	pressure psi	flow rate gpm	flow rate gpm	effectiveness %
Cascade 14727 1½ NH by 2½ NH by 2½ NH	50	43	81	7	155	74	91
	100	86	114	10	205	91	80
	150	128	137	11	229	92	67
	200	171	156	13	254	98	63
	250	216	174	15	270	96	55
Penberthy 2½ LH 2 NPT by 2½ NPT by 2½ NPT	50	32	128	8	190	62	48
	100	66	179	13	249	70	39
	150	99	216	17	280	64	30
	200	134	251	19	311	60	24
	250	169	281	22	330	49	17

American National Fire Hose Connection Screw Thread (NH); National Pipe Thread (NPT)

APPENDIX C

**Comparisons of Ejectors From Greatest to Least
Water Pickup**

Comparisons of Ejectors From Greatest to Least Water Pickup

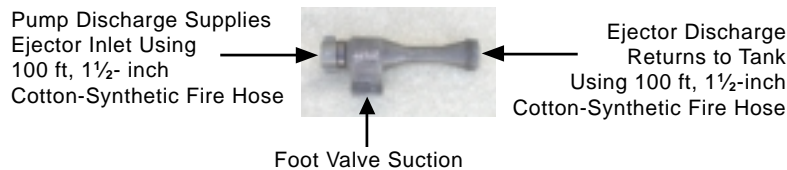

Inlet by Suction by Discharge
 Example: 1½ NPT by 1½ NPSH by 1½ NPSH

Table C1—Ejector Water Pickup comparison chart arranged from greatest to least water pickup.

Lift Ft	Lift psi	Pump Discharge Pressure psi	Water Pickup – gpm						
			Penberthy 1¼ LL ¾ NH by 1½ NPT by 1½ NPT	Cascade 14726 1 NPSH by 1½ NH by 1½ NH	Penberthy 1½ LL 1½ NPT by 1½ NPSH by 1½ NPSH	Penberthy 1½ LM 1½ NPT by 1½ NPSH by 1½ NPSH	Penberthy 1¼ LM 1 NPSH by 1½ NPT by 1½ NPT	Penberthy 1¼ LH 1 NPSH by 1½ NPT by 1½ NPT	Penberthy 1½ LH 1½ NPT by 1½ NPSH by 1½ NPSH
0	0	25	7	6	10	15	11	12	6
		50	14	13	14	15	14	14	10
		100	22	24	25	27	19	17	18
		150	27	33	32	34	22	19	23
		200	29	40	37	37	24	20	26
		250	26	44	36	34	23	20	28
20	8.6	25	~	~	~	~	2	2	~
		50	4	~	~	~	6	5	~
		100	15	13	14	15	13	9	3
		150	23	25	25	26	18	12	11
		200	27	34	32	32	21	15	17
		250	27	40	35	33	22	17	22
40	17.2	25	~	~	~	~	~	~	~
		50	~	~	~	~	~	~	~
		100	6	1	2	~	6	~	~
		150	17	15	15	15	12	5	~
		200	24	26	26	25	17	9	7
		250	26	35	31	30	20	12	14
60	25.8	25	~	~	~	~	~	~	~
		50	~	~	~	~	~	~	~
		100	~	~	~	~	~	~	~
		150	9	3	4	2	6	~	~
		200	18	17	18	16	12	3	~
		250	24	28	26	24	17	7	5
80	34.4	25	~	~	~	~	~	~	~
		50	~	~	~	~	~	~	~
		100	~	~	~	~	~	~	~
		150	~	~	~	~	~	~	~
		200	12	6	8	5	6	~	~
		250	20	20	19	16	13	1	~
Water pumped to ejector gpm		25	8	15	9	13	12	21	34
		50	10	19	17	26	16	27	43
		100	15	27	24	36	21	38	60
		150	18	33	30	44	26	47	75
		200	20	38	34	50	30	54	87
		250	23	41	38	56	33	61	96

* Example: What is the water pickup of a Cascade model 14726 ejector when used to lift water 40 ft with a pump discharge pressure of 150 psi? The water pickup will be 15 gpm, with a pump discharge flow rate of 33 gpm. Under the same conditions, a Penberthy ejector model 1½ LH will require a pump discharge flow rate of 75 gpm, and there will be no water pickup because each ejector contains a different internal configuration of nozzle and venturi.

National Pipe Standard Hose (NPSH); American National Fire Hose Connection Screw Thread (NH); National Pipe Thread (NPT)

APPENDIX D

Friction Loss of Forestry Hoses

Friction Loss of Forestry Hoses

Table D1—Friction loss comparison of the forestry hose and hose on the Forest Service Qualified Products Lists for 5100-186 and 5100-187 in units of psi/100 ft

Flow	5/8-in Garden Hose	3/4-in Straight Hardline	3/4-in Reeled Hardline	1 inch Cotton-Synthetic - 186			1 inch All Synthetic - 187			
				Imperial	Niedner	National	Mercedes	Imperial	National	Niedner
gpm	psi/100 ft	psi/100 ft	psi/100 ft	psi/100 ft	psi/100 ft	psi/100 ft	psi/100 ft	psi/100 ft	psi/100 ft	psi/100 ft
5	6	5	6	1	1	1	1	0	1	1
10	23	13	17	2	3	3	3	2	4	3
15	45	27	34	5	3	6	5	4	8	9
20	78	42	53	8	10	10	7	8	16	18
25	92	62	79	12	14	17	11	12	25	29
30	~	86	109	18	19	24	14	18	35	42
35	~	91	115	22	25	28	20	24	48	57
40	~	~	~	28	33	37	22	31	61	75
45	~	~	~	35	41	46	24	39	77	~
50	~	~	~	42	50	55	29	48	86	~
60	~	~	~	60	68	73	41	64	~	~
70	~	~	~	65	~	~	55	~	~	~
80	~	~	~	~	~	~	~	~	~	~
90	~	~	~	~	~	~	~	~	~	~
100	~	~	~	~	~	~	~	~	~	~

Table D1—Continued—Friction loss (psi/100 ft) comparison

Flow	1 1/2-in Cotton-Synthetic - 186		1 1/2-in All Synthetic - 187				1 1/2-in Hotline	1 3/4-in Hotline
	Imperial	National	Mercedes	Imperial	National	Niedner		
gpm	psi/100 ft	psi/100 ft	psi/100 ft	psi/100 ft	psi/100 ft	psi/100 ft	psi/100 ft	psi/100 ft
5	0	0	0	0	1	0	0	0
10	1	0	0	0	1	1	0	0
15	1	1	1	1	1	1	1	0
20	2	1	2	1	2	2	2	0
25	3	2	2	2	3	3	3	2
30	3	3	2	3	4	5	5	2
35	4	4	4	4	5	7	6	2
40	5	5	4	5	7	8	8	2
45	6	7	6	6	8	11	10	3
50	8	8	6	7	11	13	12	3
60	9	12	7	9	16	20	18	5
70	12	17	9	12	21	26	24	6
80	16	22	12	15	23	33	31	8
90	20	27	15	19	30	42	39	11
100	25	29	19	24	32	52	~	14

Appendix D

Table D2—Flow rate versus friction loss of forestry hose and hose on the Forest Service 5100-186 and 5100-187 Qualified Products Lists for forestry hose.

Flow Rate	5/8-in Garden Hose	3/4-in Hard Line	1-in Cotton Synthetic*		1-in Synthetic**		1 1/2-in Cotton Synthetic*		1 1/2-in Synthetic**		1 3/4-in Comm.
			QPL Low Fx	QPL High Fx	QPL Low Fx	QPL High Fx	QPL Low Fx	QPL High Fx	QPL Low Fx	QPL High Fx	
Gpm	psi/100ft										
5	6	5	1	1	0	1	0	0	0	0	0
10	23	13	2	3	2	3	1	0	0	1	0
15	45	27	5	6	4	9	1	1	1	1	0
20	78	42	8	10	8	18	2	1	2	2	0
25	92	62	12	17	12	29	3	2	2	3	2
30	-	86	18	24	18	42	3	3	2	5	2
35	-	91	22	28	24	57	4	4	4	7	2
40	-	-	28	37	31	75	5	5	4	8	2
45	-	-	35	46	39	-	6	7	6	11	3
50	-	-	42	55	48	-	8	8	6	13	3
60	-	-	60	73	64	-	9	12	7	20	5
70	-	-	65	-	-	-	12	17	9	26	6
80	-	-	-	-	-	-	16	22	12	33	8
90	-	-	-	-	-	-	20	27	15	42	11
100	-	-	-	-	-	-	25	29	19	52	14

*All 1-in and 1 1/2-in fire hose was constructed in accordance with Forest Service Specifications 5100-186a.

**All 1-in and 1 1/2-in fire hose was constructed in accordance with Forest Service Specifications 5100-187c.

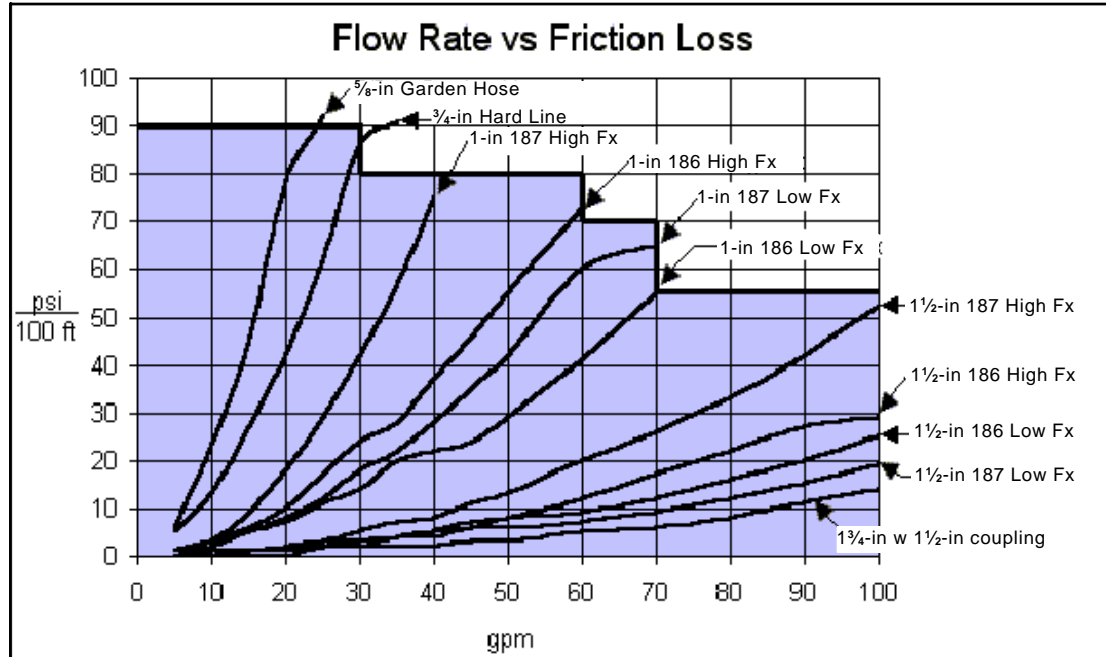

Figure D1—Flow rate versus friction loss per 100 ft of forestry hose and hose on the Forest Service 5100-186 and 5100-187 Qualified Products Lists for forestry hose.

*Fx = Friction

APPENDIX E

Product Description of Ejectors and Required Connections and Fittings

Product Descriptions of Ejectors and Required Connections and Fittings

Penberthy Ejector Model 1¼ LL

American National Fire Hose Connection Screw Thread (NH); National Pipe Thread (NPT); National Pipe Standard Hose (NPSH)

¾ 11½ NH by 1½ NPT by 1½ NPT

Material: Cast Iron Wt: 2.5 lb

Cost: \$166.40

Length by Width by Depth:

9⅛ in by 2½ in by 3⅛ in



Figure E1—Penberthy Ejector Model 1¼ LL configuration.

Table E1—Connection and fittings required for Penberthy Ejector Model 1¼ LL

When Using		Connection and Fittings Required		
Inlet	1 NPSH Fire Hose	1 NPSH by 1 NPSH Double Female Coupling		¾ 11½ NH by 1 NPSH Reducer
	1½ NH Fire Hose	1½ NH by 1 NPSH Reducer	1 NPSH by 1 NPSH Double Female Coupling	¾ 11½ NH by 1 NPSH Reducer
Suction	1½ NPSH Foot Valve	1½ NPT by 1½ NPSH Adapter		
Discharge	1½ NH Fire Hose	1½ NPT by 1½ NPSH Adapter	1½ NPSH by 1½ NH Adapter	

Cascade Ejector Model 14726

National Pipe Standard Hose (NPSH); American National Fire Hose Connection Screw Thread (NH);

1 NPSH by 1½ NH by 1½ NH

Material: Cast Aluminum Alloy

Wt: 1.2 lb

Cost: \$122.50 GSA SIN: 567-15

Length by Width by Depth:

9½ in by 2½ in by 3⅝ in

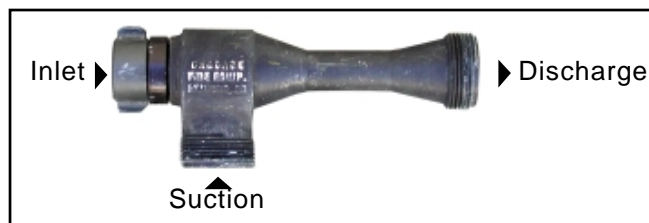

Figure E2—Cascade Ejector Model 14726 configuration.

Table E2—Connection and fittings required for Cascade Ejector Model 14726

When Using		Connection and Fittings Required	
Inlet	1 NPSH Fire Hose	~	
	1½ NH Fire Hose	1½ NH by 1 NPSH Reducer	
Suction	1½ NPSH Foot Valve	1½ NH by 1½ NPSH Adapter	
Discharge	1½ NH Fire Hose	~	

Penberthy Ejector Model 1½ LL

National Pipe Thread (NPT); National Pipe Standard Hose (NPSH); American National Fire Hose Connection Screw Thread (NH)

1½ NPT by 1½ NPSH by 1½ NPSH

Material: Cast Iron Wt: 3.5 lb

Cost: \$215.20

Length by Width by Depth:

11 in by 2¾ in by 3½ in

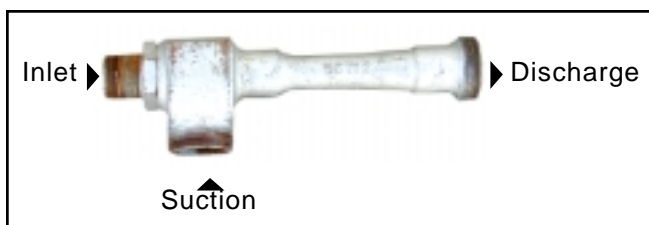

Figure E3—Penberthy Ejector Model 1½ LL configuration.

Table E3—Connection and fittings required for Penberthy Ejector Model 1½ LL

When Using		Connection and Fittings Required	
Inlet	1 NPSH Fire Hose	1 NPSH by 1 NPSH Double Female Coupling	
	1½ NH Fire Hose	1½ NH by 1 NPSH Reducer	1 NPSH by 1 NPSH Double Female Coupling
Suction	1½ NPSH Foot Valve	~	
Discharge	1½ NH Fire Hose	1½ NPSH by 1½ NH Adapter	

Appendix E

Penberthy Ejector Model 1½ LM

National Pipe Thread (NPT); National Pipe Standard Hose (NPSH);
American National Fire Hose Connection Screw Thread (NH)

1½ NPT by 1½ NPSH by 1½ NPSH

Material: Cast Iron Wt: 3.5 lb

Cost: \$215.20

Length by Width by Depth:

11 in by 2¾ in by 3½ in

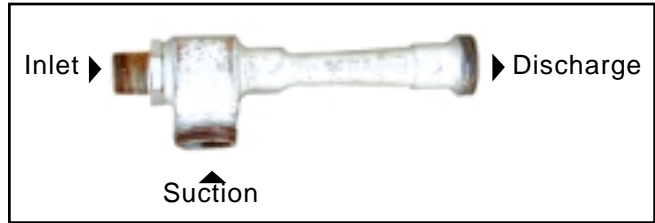

Figure E4—Penberthy Ejector Model 1½ LM configuration.

Table E4—Connection and fittings required for Penberthy Ejector Model 1½ LM

When Using		Connection and Fittings Required	
Inlet	1 NPSH Fire Hose	1 NPSH by 1 NPSH Double Female Coupling	
	1½ NH Fire Hose	1½ NH by 1 NPSH reducer	1 NPSH by 1 NPSH Double Female Coupling
Suction	1½ NPSH Foot Valve	~	
Discharge	1½ NH Fire Hose	1½ NPSH by 1½ NH Adapter	

Penberthy Ejector Model 1¼ LM

National Pipe Standard Hose (NPSH); National Pipe Thread (NPT);
American National Fire Hose Connection Screw Thread (NH)

1 NPSH by 1½ NPT by 1½ NPT

Material: Cast Iron Wt: 2.6 lb

Cost: \$166.40

Length by Width by Depth:

9⅞ in by 2½ in by 3⅞ in

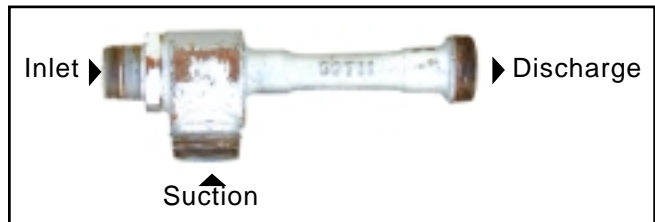

Figure E5—Penberthy Ejector Model 1¼ LM configuration.

Table E5—Connection and fittings required for Penberthy Ejector Model 1¼ LM

When Using		Connection and Fittings Required	
Inlet	1 NPSH Fire Hose	1 NPSH by 1 NPSH Double Female Coupling	
	1½ NH Fire Hose	1½ NH by 1 NPSH reducer	1 NPSH by 1 NPSH Double Female Coupling
Suction	1½ NPSH Foot Valve	1½ NPT by 1½ NPSH Adapter	
Discharge	1½ NH Fire Hose	1½ NPT by 1½ NPSH Adapter	1½ NPSH by 1½ NH Adapter

Penberthy Ejector Model 1¼ LH

National Pipe Standard Hose (NPSH); National Pipe Thread (NPT);
American National Fire Hose Connection Screw Thread (NH)

1 NPSH by 1½ NPT by 1½ NPT

Material: Bronze Wt: 3.1 lb

Cost: \$190.40

Length by Width by Depth:

9⅞ in by 2½ in by 3⅞ in

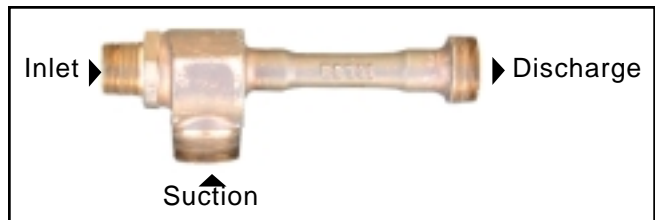

Figure E6—Penberthy Ejector Model 1¼ LH configuration.

Table E6—Connection and fittings required for Penberthy Ejector Model 1¼ LH

When Using		Connection and Fittings Required	
Inlet:	1 NPSH Fire Hose	1 NPSH by 1 NPSH Double Female Coupling	
	1½ NH Fire Hose	1½ NH by 1 NPSH Reducer	1 NPSH by 1 NPSH Double Female Coupling
Suction	1½ NPSH Foot Valve	1½ NPT by 1½ NPSH Adapter	
Discharge	1½ NH Fire Hose	1½ NPT by 1½ NPSH Adapter	1½ NPSH by 1½ NH Adapter

Penberthy Ejector Model 1½ LH

National Pipe Standard Hose (NPSH); National Pipe Thread (NPT); American National Fire Hose Connection Screw Thread (NH)
 1½ NPT by 1½ NPSH by 1½ NPSH
 Material: Cast Iron Wt: 3.7 lb
 Cost: \$215.20
 Length by Width by Depth:
 11 in by 2¾ in by 3½ in

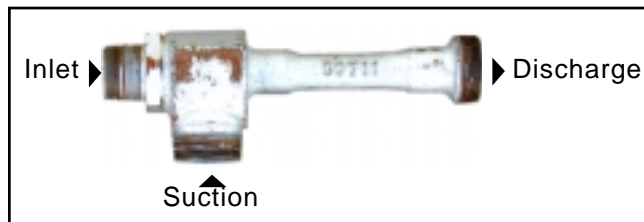

Figure E7—Penberthy Ejector Model 1½ LH configuration.

Table E7—Connection and fittings required for Penberthy Ejector Model 1½ LH

When Using		Connection and Fittings Required			
Inlet	1 NPSH Fire Hose	1½ NPT by 1½ NPSH Adapter	1½ NPSH by 1½ NH Adapter	1½ NH by 1 NPSH Reducer	1 NPSH by 1 NPSH Double Female Coupling
	1½ NH Fire Hose	1½ NPT by 1½ NPSH Adapter	1½ NPSH by 1½ NH Adapter	1½ NH by 1½ NH Double Female Coupling	
Suction	1½ NPSH Foot Valve	~			
Discharge	1½ NH Fire Hose	1½ NPSH by 1½ NH Adapter			

Cascade Ejector Model 14727

National Pipe Standard Hose (NPSH); National Pipe Thread (NPT); American National Fire Hose Connection Screw Thread (NH)
 1½ NH by 2½ NH by 2½ NH
 Cast Aluminum Alloy
 Wt: 4.8 lb
 Cost: \$290.00
 Length by Width by Depth:
 18¼ in by 4½ in by 6 in



Figure E8—Cascade Ejector Model 2½ configuration.

Table E8—Connection and fittings required for Cascade Ejector Model 14727

When Using		Connection and Fittings Required
Inlet	1½ NH Fire Hose	~
Suction	2½ NPSH Foot Valve	2½ NPSH—2½ NPSH Adapter
Discharge	2½ NH Fire Hose	~

Penberthy Ejector Model 2½ LH

National Pipe Standard Hose (NPSH); National Pipe Thread (NPT); American National Fire Hose Connection Screw Thread (NH)
 2 NPT by 2½ NPT by 2½ NPT
 Material: Cast Iron Wt: 11.0 lb
 Cost: \$412.20
 Length by Width by Depth:
 18⅞ in by 4¾ in by 5¾ in

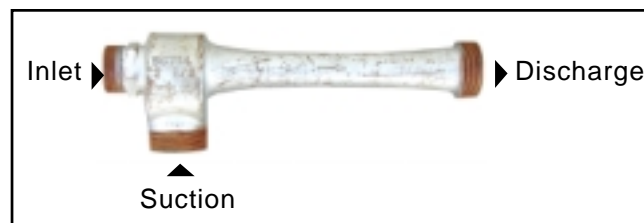

Figure E9—Penberthy Ejector Model 2½ LH configuration.

Table E9—Connection and fittings required for Penberthy Ejector Model 2½ LH

When Using		Connection and Fittings Required	
Inlet	1½ NH Fire Hose	2 NPT by 1½ NH Adapter	1½ NH by 1½ NH Double Female Coupling
Suction	2½ NPSH Foot Valve	~	
Discharge	2½ NH Fire Hose	2½ NPSH—2½ NH Adapter	

ENGLISH TO METRIC CONVERSION FACTORS USED IN THIS DOCUMENT

To Change	To	Multiply by
inches	millimeters	25.4
feet	meters	0.305
gallons	liters	3.785
gallons per minute	liters per second	0.063
pounds per square inch	kilopascal	6.895
pounds	kilogram	0.454

